

A WORK OF ART POWERED BY AIR.®

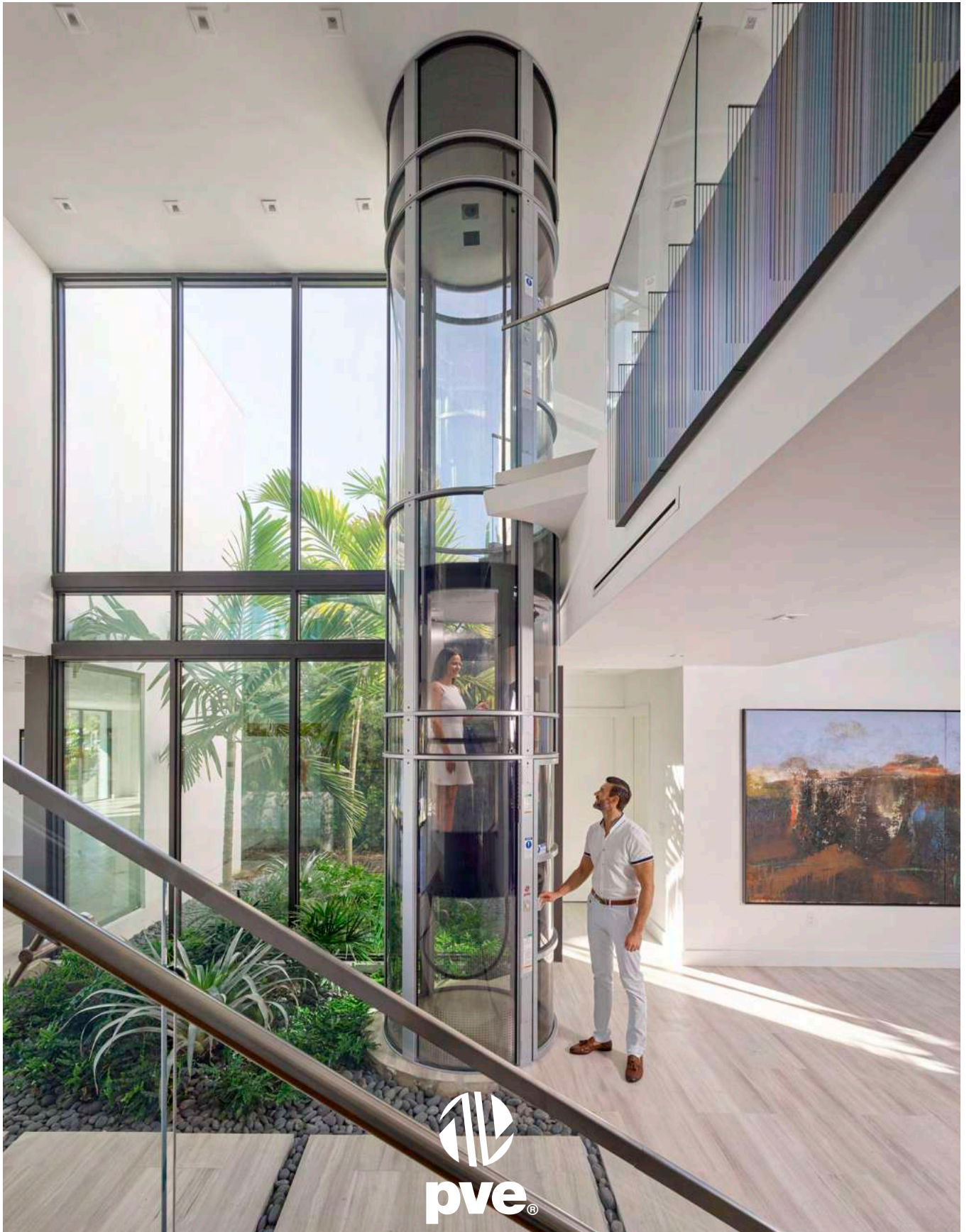

www.VacuumElevators.com

BIG IDEAS REVOLUTIONIZE THE WORLD

FOUNDED IN 2002

Pneumatic Vacuum Elevators, LLC (PVE) is the inventor and sole manufacturer of the world's only Air-Driven Home Elevator, the Pneumatic Elevator.

Manufactured in Miami, Florida, USA, PVE is an innovative, technology driven company that thinks outside of the box, having our customers always in mind and our engineering capabilities second to none.

Powered by the most abundant resource in the world, AIR, Pneumatic Elevators are innovative, space-saving home lift solutions that have revolutionized the way people and goods are transported vertically in their homes.

Utilizing materials and components of the highest quality available, Pneumatic Elevators unique design is based around our patented technology and PVE is proud to manufacture fully certified, safe and reliable home elevators for use worldwide.

Using Pneumatic Technology® to generate lift, these self-supporting, panoramic elevators smoothly move between floors while requiring much less space, energy & maintenance when compared to traditional elevators.

With over 20,000 successful installations in over 100 countries, PVE has customers and authorized distributors across the globe, ensuring all end users the best quality of installation and service.

With three models to choose from, ranging from a single passenger to a three passenger wheelchair-accessible model, Pneumatic Elevators simply rest on the existing ground floor, offering an ease of installation while providing an aesthetically pleasing solution for both retro-fit & new construction projects.

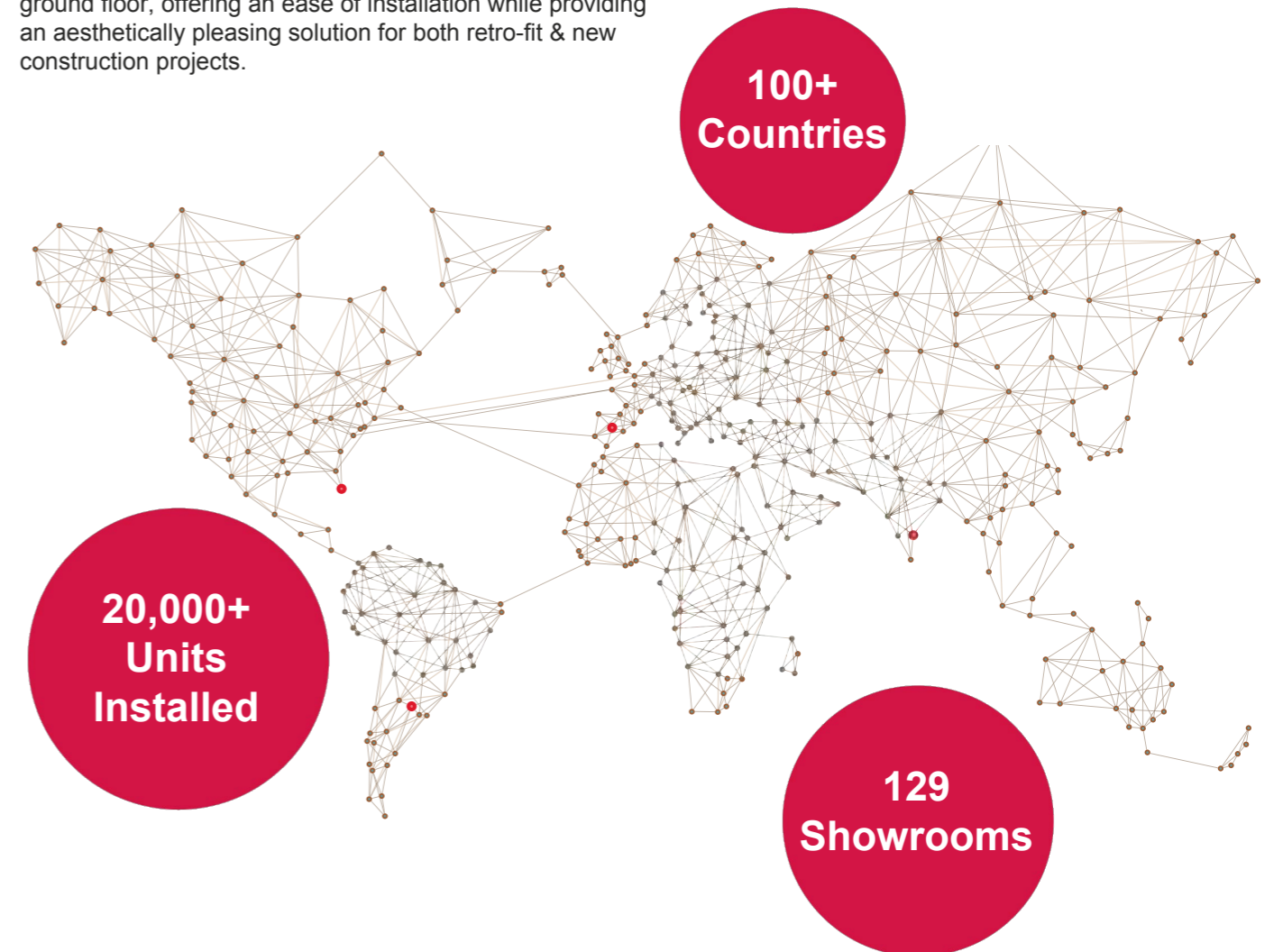

Model: PVE37
Customization: Clear Polycarbonate Panels
Upgrades: Top Floor Extension, Split-Unit Mount
Color: Black

System of Operation For The Pneumatic Elevator

1. During ascent, the system extracts air from the top, creating a vacuum that makes the elevator car go upwards.

2. For descent, the intake of air is controlled, causing the car to smoothly move downwards due to gravity.

Pneumatic Technology® simplifies the operation while reducing wear and tear of components: a smooth, safe & reliable system.

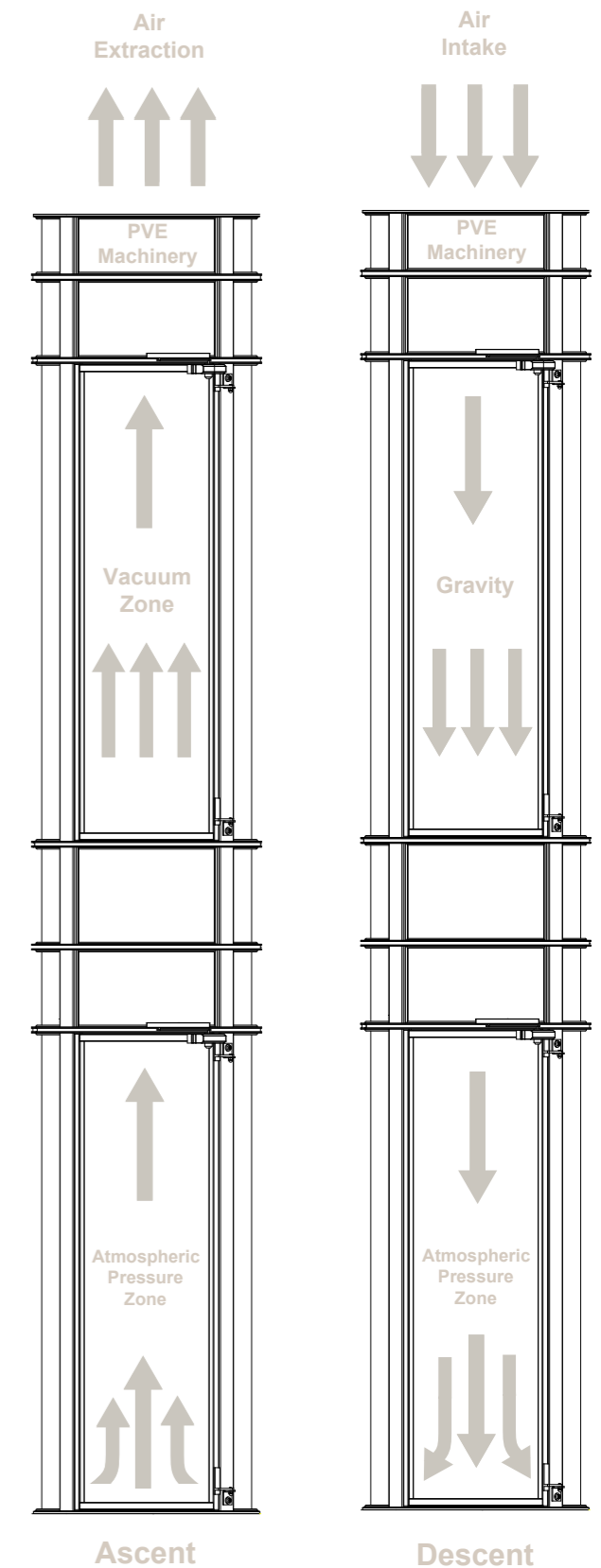

INNOVATIVE SOLUTION

By using Pneumatic Technology® to generate areas of higher and lower pressure within the cylinder hoistway, Pneumatic Elevators combine a vertical cylinder with a fully enclosed car that smoothly moves up and down through air suction and gravity.

What advantages do Pneumatic Elevators offer?

Not requiring a pre-construction shaft, pit or machine room, Pneumatic Elevators simply rest on the existing ground floor, offering more flexibility of installation while optimizing space within the home.

With minimal pre-construction requirements, Pneumatic Elevators are quick & easy to install with installations being completed in as little as 2 - 3 days.

A plug & play system requiring a 220 volt power supply, these eco-friendly elevators utilize very few moving parts during operation and have minimal maintenance requirements with no harmful oils, gases or lubricants utilized for operation.

Certified for up to 5 stops or 50 feet in total rise, Pneumatic Elevators are custom built to the height of each home with three different sizes available to meet your projects spatial and installation requirements.

Components

There are three main components to the transparent, self-supporting Pneumatic Elevator:

Exterior Cylinder - Made up of an aluminum frame and polycarbonate panels that offers panoramic visibility.

Elevator Car - Fully welded and enclosed cabin made of steel, which houses the brake and safety mechanisms along with the proprietary seal located on top of the car.

PVE Machinery - Installed on top of the upper floor cylinder or remotely located. Houses the turbine motors, valves and PVE controller used to operate the elevator.



Model: PVE52
 Customization: Custom Right Hand Doors
 Color: White

ELEGANT DESIGN

At PVE, our mission is to create home elevator solutions in which design and technology coincide. Where the utilization of attractive materials and the application of fundamental physics combine to produce an innovative & aesthetically pleasing elevator that enhances homeowners standard of living.

The result: **Pneumatic Elevators.**

With its minimal footprint, modern design & revolutionary technology, these eco-friendly elevators go where other home elevators simply cannot.

A versatile solution that fits into even the tightest of spaces, all three Pneumatic Elevator models are self-supporting with minimal pre-construction requirements allowing a faster & more flexible installation.

Utilizing a unique, circular design, these panoramic elevators offer 360° degree visibility while traveling up to 5 stops or 50 feet in total rise making them beautiful additions to any residence.

"Green Elevators" that operate using Pneumatic Technology®, minimal energy consumption is utilized during ascent and gravity is simply used for descent ensuring Pneumatic Elevators have a nominal impact to your annual electrical usage.

REMAIN IN THE COMFORTS OF YOUR HOME

Model: PVE30
Color: Anodized Silver

ABSOLUTE SAFETY

Pneumatic Elevators are annually certified & safety inspected by the prestigious Liftinstituut, one of the world's leading elevator certification organizations.

In the event of power failure while in operation, the Elevator Cab will automatically descend to the lowest level and the mechanical door lock opens to allow passengers to exit.

PVE|7

MADE IN U.S.A

Unlike other foreign manufactured products on the market, Pneumatic Elevators are manufactured in Miami, Florida, USA ensuring each elevator produced by PVE meets the strictest quality & safety standards.

The safety of our customers is paramount, with every Pneumatic Elevator pre-assembled & safety tested at our PVE Factory Headquarters prior to installation.

PVE|8

3 MODELS AVAILABLE

With 3 Models Available, There Is A Pneumatic Elevator To Fit Any Projects' Needs.

PVE MODEL SPECIFICATIONS

Specifications For All 3 Pneumatic Elevator Models Available.



PVE30

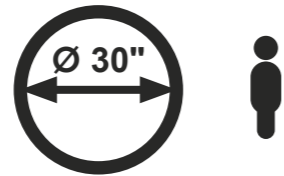

Single passenger elevator
 External cylinder diameter: 30 inches (750 mm)
 350 lbs lift capacity (159 kg)
 40 ft/min traveling speed
 Automatic interior LED lighting and fan
 In-line door openings **



PVE37



Two passenger elevator
 External cylinder diameter: 37 inches (950 mm)
 450 lbs lift capacity (205 kg)
 40 ft/min traveling speed
 Automatic interior LED lighting and fan
 In-line, walk-through and 90° door openings **
 *Limitations with 90° Door Openings



PVE52

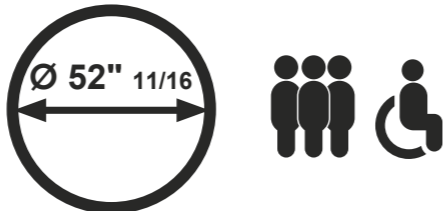

Three passenger elevator
 Wheelchair accessible
 External cylinder diameter: 52 11/16 inches (1,338 mm)
 525 lbs lift capacity (238 kg)
 35 ft/min traveling speed
 Automatic interior LED lighting and fan
 In-line and walk-through door openings **

PVE|9

	PVE30	PVE37	PVE52
General			
Maximum Load (lbs)	350	450	525
Speed	40 fpm (.15 m/s)	40 fpm (.15 m/s)	35 fpm (.15 m/s)
Number of Stops	2 to 5	2 to 5	2 to 5
Maximum Distance (Feet)	50	50	50
Car			
Inside Diameter - Widest Point (Inches)	25"	32" 1/2	46" 3/4
Doorway Width (Inches)	20"	20" 1/2	32"
One-Touch Operation	Yes	Yes	Yes
Wheelchair Accessible	No	No	Yes
Doors			
Available Entrances **	0°	0°, 90°, 270° and 180°	0° and 180°
Possibility of an Automatic Door	Yes	Yes	Yes
Safety			
Power Failure Automatic Descent	Yes	Yes	Yes
Alarm Button / Safety Telephone	Yes	Yes	Yes
Electricity			
Supply	220 V/20 A	220 V/30 A	220 V/40 A
Power	3.8 kW	6 kW	7 kW
Installation Requirements			
Finished Perforation Diameter (Inches)	32"	39"	54" 11/16
Minimum Height on Upper Floor (Inches) *	97" *	97" *	97" *

* Lower Height Clearances are possible. Speak to a PVE Sales Representative to confirm the feasibility of your desired installation.

** Door Configuration Options available for review on Page 25.

PVE|10

PVE30

PVE30



Rated Load
350 lbs

Model: PVE30
Color: Anodized Silver

PVE37

PVE37

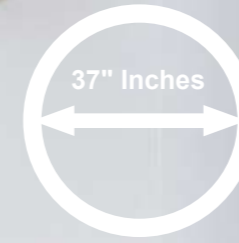

Rated Load
450 lbs

Model: PVE37
Upgrade: Cabin Folding Seat
Color: White



PVE52



Rated Load
525 lbs

Model: PVE52
Color: Anodized Silver

PVE MACHINERY CONFIGURATIONS

Depending On The Available Height In Your Home,
There Are Different PVE Machinery Configurations Available For Your Pneumatic Elevator:

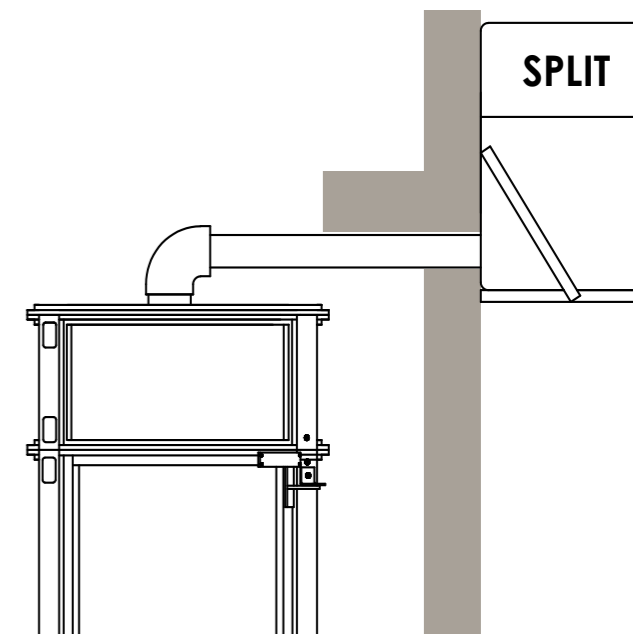
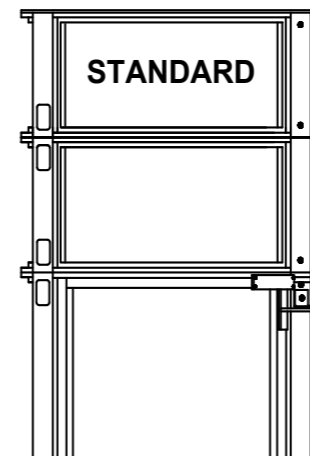

STANDARD MOUNT CONFIGURATION

A quick to install, aesthetically pleasing solution, Standard Mounted applications allow for the PVE Machinery to be installed directly on top of the upper-floor cylinder.

The simplest solution in terms of installation, Standard Mounted applications are plug & play systems that require a 220 volt power supply to be located directly above or close to the top of the unit.

MINIMUM HEIGHT ON THE UPPER FLOOR

107" Inches *

* Lower Height Clearances are possible. Speak to a PVE Sales Representative to confirm the feasibility of your desired installation.

SPLIT-UNIT MOUNT CONFIGURATION

Designed to accommodate installations with lower overhead clearances, Split-Unit Mounted applications allow for the PVE machinery to be remotely located from the top of the unit.

With both Indoor and Outdoor Split-Unit options, remotely locating the machinery reduces the minimum height required on the top floor with the PVE machinery installed up to 30 linear feet away from the top of the upper-floor cylinder.

Connected to the top of the elevator by two 4" inch PVC pipes or a flex hose alternative, Split-Unit Mounted Applications requires a 220 volt power supply to be located wherever the PVE Controller is installed.

MINIMUM HEIGHT ON THE UPPER FLOOR

97" Inches *



PVE|13



PVE|14

STANDARD MOUNT

PVE Machinery Installed Directly Above The Unit.

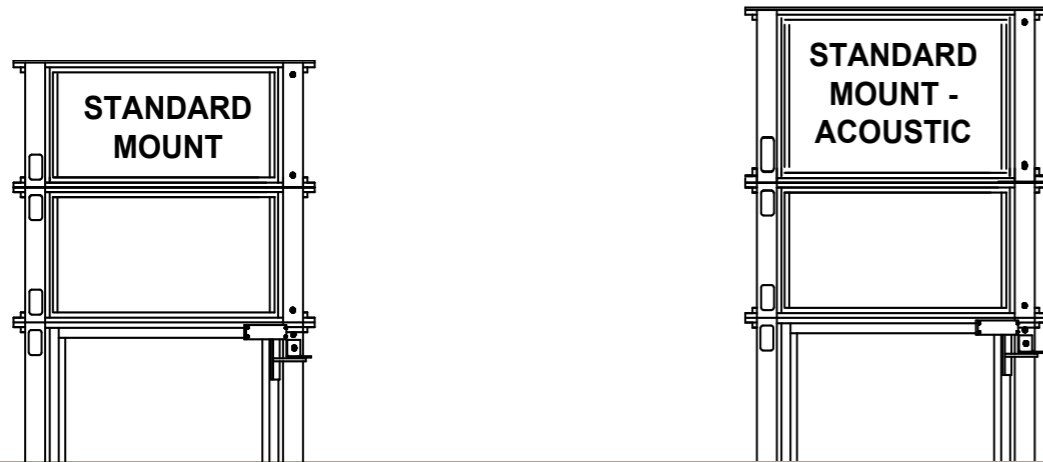

STANDARD MOUNT

Included as the base PVE Machinery option for all Pneumatic Elevator orders, a Standard Mounted application allows for the PVE Machinery to be installed directly on top of the upper floor cylinder.

ADVANTAGES

- Standard Mounted Machinery
- Quick & Easy Installation
- Self-Contained, Plug & Play Operation

MINIMUM HEIGHT ON UPPER FLOOR

105" Inches *

STANDARD MOUNT ACOUSTIC

Utilizing audio engineering and sound proofing material to reduce decibel ratings, the Standard Mount - Acoustic upgrade option allows for the PVE machinery to be installed directly on top of the upper floor cylinder.

ADVANTAGES

- Decibel Reducing Solution for Standard Mounted Applications
- Plug & Play System
- Easy-to-Install Machinery Option

MINIMUM HEIGHT ON UPPER FLOOR

107" Inches *

* Lower Height Clearances are possible. Speak to a PVE Sales Representative to confirm the feasibility of your desired installation.

SPLIT-UNIT MOUNT

PVE Machinery Remotely Located Up To 30 Linear Feet Away From The Top Of The Unit.

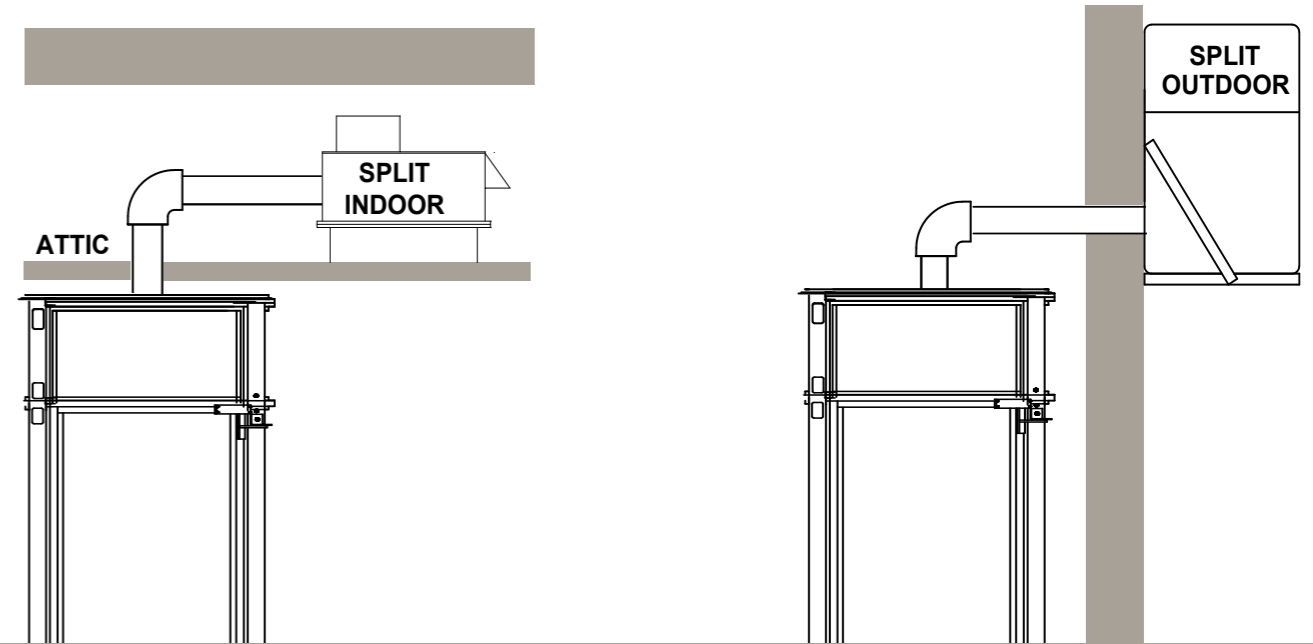

SPLIT-UNIT MOUNT INDOOR

Designed to accommodate installations with lower Overhead Clearances on the top floor, the Split-Unit Mount - Indoor machinery option is an upgrade that allows the PVE Machinery to be installed remotely inside the home.

Connected to the top of the elevator by two 4" inch PVC pipes or a flex hose alternative, the Split-Unit machinery can be installed up to 30 linear feet away from the top of the unit and is often located in attics, adjacent closets or mechanical rooms within the home.

ADVANTAGES

- Lower Overhead Clearance Requirements on the Top Floor
- Reduction of Decibel Ratings Inside Home
- Customizable Positioning of the Split-Unit Machinery Inside the Home.

MINIMUM HEIGHT ON UPPER FLOOR

97" Inches *

SPLIT-UNIT MOUNT OUTDOOR

Designed to allow the PVE Machinery to be installed externally from the home, the Split-Unit Mount - Outdoor machinery option is an upgrade designed to allow the PVE Machinery to be installed in an exterior setting.

Installed inside a fiber glass enclosure, this PVE Machinery solution is connected to the top of the elevator by two 4" inch PVC pipes or a flex hose alternative and can be installed outside up to 30 linear feet away from the top of the unit.

ADVANTAGES

- Lower Floor-to-Ceiling Height Requirement on the Top Floor
- Most Efficient Audio Solution for PVE Machinery
- Customizable Positioning of Split-Unit Machinery Outside the Home.

MINIMUM HEIGHT ON UPPER FLOOR

97" Inches *

PVE INSTALL

APPLICATIONS

BALCONY WITH LANDING

EMBEDDED BALCONY

THROUGH-FLOOR

Balcony Band
Balcony Landing

BALCONY APPLICATION

When the elevator is installed in an open space, a double-height area, in-door mezzanine or a stairwell where it's not applicable to have a through-floor hole.

For Balcony Applications, it's necessary to install a **Landing, Platform or Walkway** (*not provided*) at the balcony level for ease of entry & exit for the passenger.

Given the elevators circular design, this pre-construction requirement covers the space between the elevator and balcony floor while ensuring stability as the Pneumatic Elevator is attached to the structure on each level by means of a **Balcony Band** (*provided by the installer*).

TYPES OF LANDINGS

Different configurations for a Walkway or Platform.



THROUGH-FLOOR APPLICATION

A finished through-floor hole is made at each level with a finished diameter 2" inches greater than the exterior diameter of the Pneumatic Elevator model. In applications with three, four or five stops, the holes must be perfectly aligned.

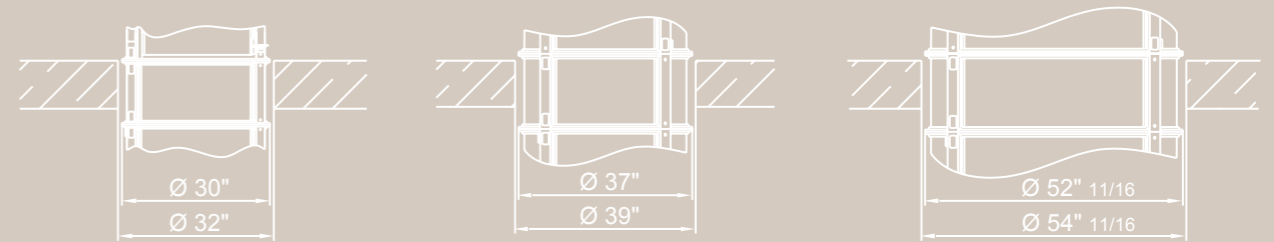

Minimum diameters for finished holes in through-floor installations.

BALCONY LANDING

For a Landing, Platform or Walkway constructed for Balcony Applications, it is recommended that the finished landing at its widest point be 1/2 inch greater than the diameter of the Pneumatic Elevator purchased. Meeting this recommendation will ensure that the Pneumatic Elevator chosen will fit properly, with a clean aesthetic.

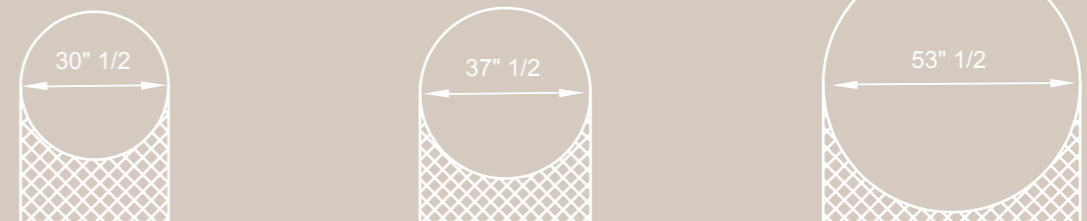

OPTIONS & UPGRADES

Enhance Your Pneumatic Elevator With These Options & Upgrades Available For All 3 Models:

COLORS OPTIONS

Powder Coated Color Finishes Available for the Exterior Aluminum Frame Of The Pneumatic Elevator:

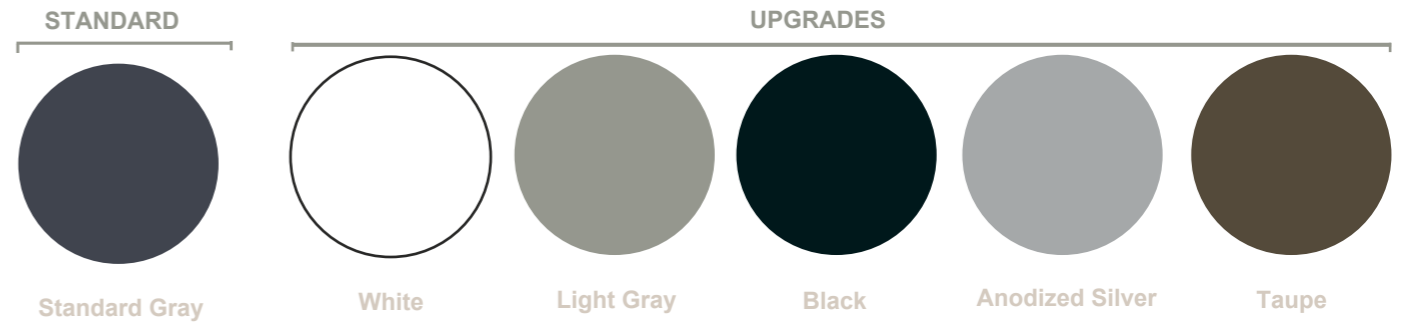

IN-CABIN UPGRADES

Upgrades Available For The Interior Cabin Of The Pneumatic Elevator:

CABIN KEY LOCK



CABIN TELEPHONE



iBUTTON KEY FOB



IN-CABIN LED CEILING PACKAGE



ELEVATOR UPGRADES

Enhance Your Pneumatic Elevator By Including Our Latest Upgrades:

SMART HOME INTEGRATION

Integrate your Pneumatic Elevator with Smart Home Devices like Amazon Alexa or Google Home to operate your elevator using voice commands and/or Smart Phones.

SOLAR PANEL PACKAGE

By Integrating your Pneumatic Elevator with Solar Panels, your home elevator will be powered solely off renewable energy (Solar + Air) while operating 100% off the grid.

TOP FLOOR EXTENSION

Extend the top of your elevator to terminate 1" inch below the ceiling for a clean aesthetic & finish.

BATTERY BACK-UP PACKAGE

Battery Back-Up Package ensures your Pneumatic Elevator is operable even if the electricity goes out inside your home.

EARTHQUAKE BRACKETS

Often installed in seismic zones, Earthquake Brackets allow the Pneumatic Elevator to be bolted to the ground floor.

REMOTE CONTROL

Command your Pneumatic Elevator in the palm of your hand with a single click by including our Remote Control. Programmable up to 5 Stops.

HOMING FEATURE

Program the cabin for your Pneumatic Elevator to automatically travel to a designated floor after a specific period of time to ensure your cabin is always waiting at a pre-programmed floor after use.

AFFORDABLE ELEGANCE

PVE37 MODEL UPGRADES

Options & Upgrades Available For The 2-Passenger, PVE37 Pneumatic Elevator:

CABIN FOLDING SEAT



Cabin Folding Seat option offers the ability for a folding seat and a handle to be installed inside the cabin. (Available only for the PVE37 model)

90° DEGREE DOOR CONFIGURATIONS

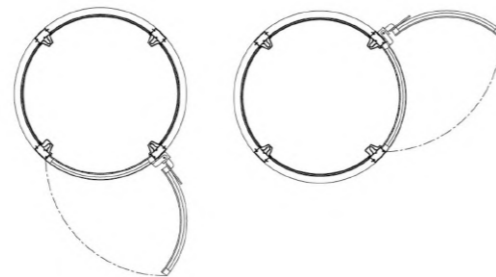

90° Degree Door Configuration allows for the upper floor doors to be directed 90° degrees to the left or 90° degrees to the right from the ground floor door. (All upper floor doors must be same side as one another)*

PVE CUSTOMIZATIONS

Available for all 3 Models, these PVE Customizations Require an Extended Production Time to Manufacture:

CUSTOM CLEAR POLYCARBONATE PANELS



Custom Clear Polycarbonate Panels offers a clearer and more transparent finish to your Pneumatic Elevator.

CUSTOM RIGHT HAND DOOR SWING



Custom Right Hand Door Swing allows the door to be hinged on the top left corner when facing the Pneumatic Elevator from outside. See drawing above for reference. (All Floors Will Have Same Door Swing On All Levels)*

AUTOMATIC DOOR OPENER/CLOSER

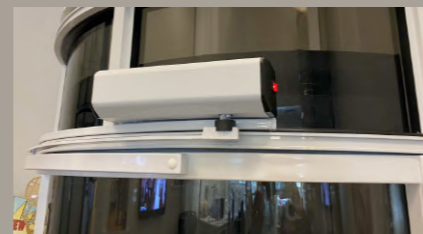

Automatic Door Opener/Closer allows the door for your Pneumatic Elevator to be programmed to automatically open & close upon arrival.

* Custom Door Configurations/Swings may be feasible depending on layout, model & project requirements. Speak to a PVE Sales Representative to confirm the feasibility of your desired installation.

DOOR CONFIGURATIONS

Door Configurations Available For Specific Pneumatic Elevator Models:

Door Openings Configuration		PVE30	PVE37	PVE52
Ground Floor	Upper Floor(s)			
- In Line 0°		●	●	●
- Opposite 180°	Possibility of alternating orientation between floors	●	●	●
- 90° Right	All upper floor doors must be same side as one another	●	●	●
- 90° Left		●	●	●

● Not available ● Available

Door Configurations Shown Above are For Standard Left Hand Door Swings. Only One Door Opening Available Per Floor/Level. Speak with a PVE Sales Representative regarding Custom Right Hand Door Configurations.

ELEVATE YOUR STANDARD OF LIVING

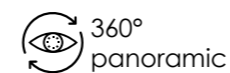

360° panoramic



Unique design



Customisable finishes



Pitless installation



Vacuum lifts



Quick installation (2-3 days)



Eco-friendly product



Maximum safety



Minimal maintenance



Plug&Play Voltage at 220v

Winner two years in a row (2018 and 2019) of the ELLIES Awards prestigious prize: **Best Supplier - Complete Elevator & Escalator Systems** presented by Elevator World, Inc.

Runner-Up Prize Awarded in 2020.





pve[®]

Pneumatic Vacuum Elevators, LLC

12602 NW 115th Ave. Medley,
FL 33137 USA
(305) 884-1091

Info@VacuumElevators.com

www.VacuumElevators.com